



ASP™ Adjustable Spring Plate kit - Instructions

Part Number 2142100

Cars applicable:

'69-'89 911/912/930



Required but not included:

- Spring plate bushings. Polybronze™ spring plate bearings are highly recommended. Any bushing designed for use with factory spring plates may be used.
- Splined hub from a pair of factory adjustable spring plates (factory equipped on '77-'89 911 series) and related height adjusting hardware. '69-'86 cars may instead use the QuickChange Splined Hub from Elephant Racing.

Introduction –

Congratulations on your purchase of the Adjustable Spring Plate (ASP™) from Elephant Racing!

ASP corrects rear suspension camber curve to maintain optimal tire contact patch. Superior grip in turns, superior grip in straight-line braking, reduced tire wear. Excellent for both street and track

ASP makes it extremely easy to setup toe and static camber, independently. Replaces the troublesome stock eccentric adjusters with simple threaded Double-Adjusters.

ASP can be fit to 911 series cars from '69 to '89. ASP works in combination with the splined hub portion of the factory adjustable spring plates as equipped on '77-'89 models. '69-'76 model cars will require donor splined hubs from a '77-'86 model car. Alternatively, cars from '69-'86 may use Elephant Racing's QuickChange™ Spring Plate splined hub.

Following installation of the ASP, a corner balance and alignment must be performed.

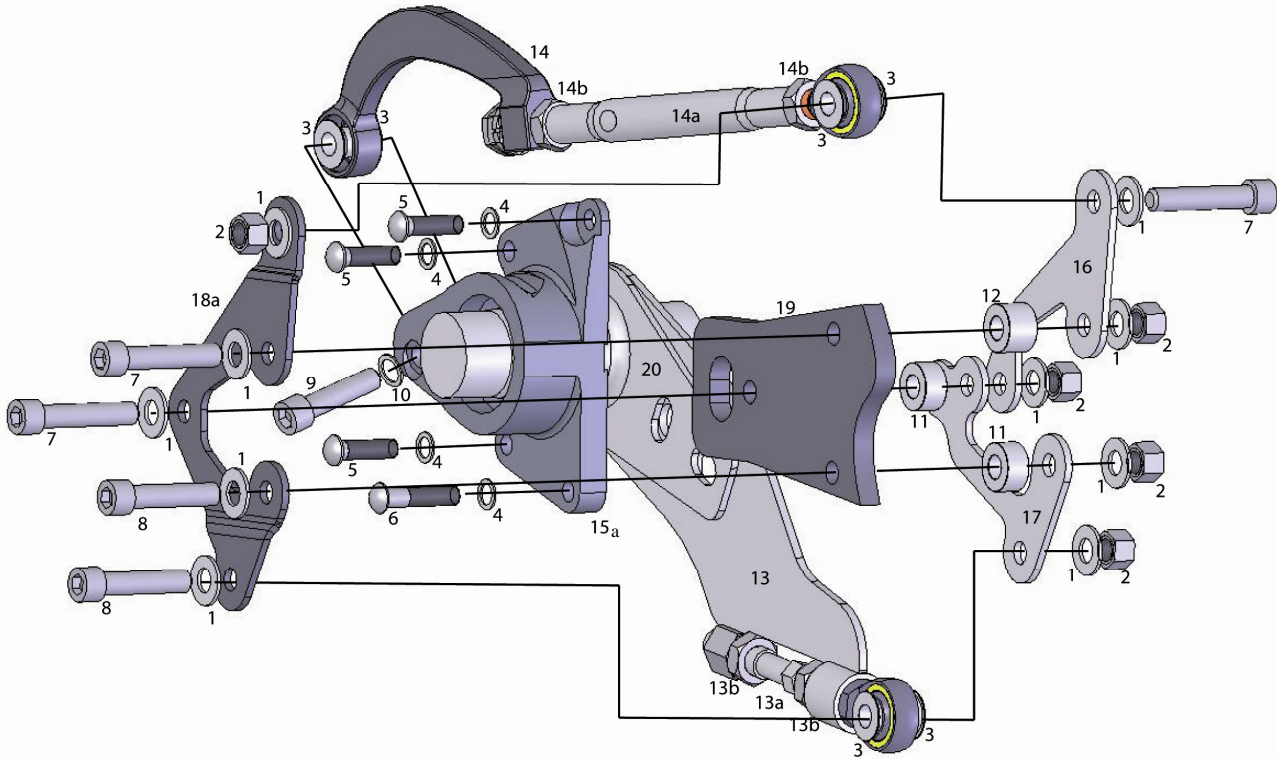

Assemble driver side ASP as shown in the above exploded view. Passenger side is assembled as a mirror image.

Item #	Quantity	Description	Torque
1	20	M12 flat washer	
2	10	M12 Nylock nut	
3	12	Rod-end spacer (pre-installed)	
4	8	M10 Schnoor lock washer	
5	6	M10 x 35 button head socket cap screw	35 ft/lbs
6	2	M10 x 50 button head socket cap screw	35 ft/lbs
7	6	M12 x 60 socket cap screw	90 ft/lbs
8	4	M12 x 55 socket cap screw	90 ft/lbs
9	2	M12 x 50 socket cap screw	60 ft/lbs
10	2	M12 Schnoor lock washer	
11	4	13mm Aluminum spacer – see notes if using steel trailing arms	
12	2	17mm Aluminum spacer –	
13	2	Blade assembly	
13a		Lower Double Adjuster – included in Blade Assembly	
13b		Lower Double Adjuster Jam Nuts – included in Blade Assembly	
14	2	Push rod assembly	
14a		Upper Double Adjuster – included in Push Rod Assembly	
14b		Upper Double Adjuster Jam Nuts – included in Push Rod Assembly	
15a	2	Spring plate cover – driver side	
15b	2	Spring plate cover – passenger side	
16	2	Upper plate	
17	2	Lower plate	
18a	1	Outer plate – driver side	
18b	1	Outer plate – passenger side – bends are a mirror of the driver side	
19		Trailing arm assembly cutaway – not included, shown for reference	
20		Splined hub from factory adjustable spring plate – not included, shown for reference	

Alternate assembly views

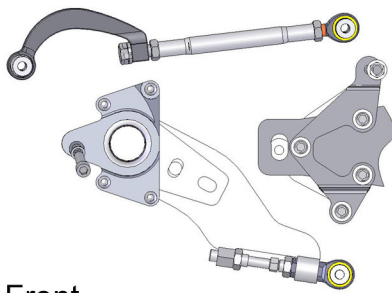

Front

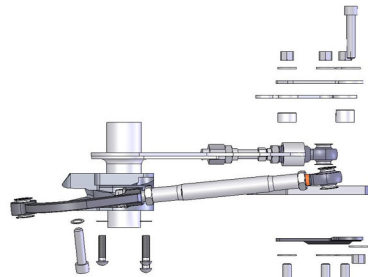

Top

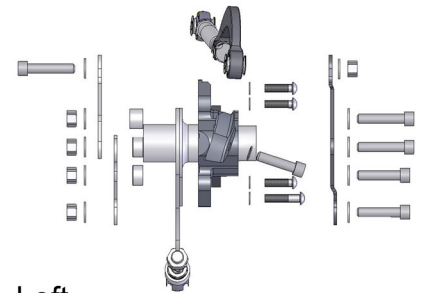

Left

Brake lines

Brake hard lines require re-routing behind (rear of car) the upper plate and lower plate.

Attaching Sway Bars

Factory and aftermarket sway bars can be used with the ASP. All factory sway bars and many aftermarket sway bar drop links can be attached to the trailing arm – this method is recommended if supported.

Factory sway bars on model years '69-'77 will physically interfere with the ASP. It is recommended to fit aftermarket sway bars, or sway bars from '78-'89 model year. Alternatively, stock '69-'77 drop links can be extended by cutting, then welding steel stock to extend the spacing between the bushings to eliminate the interference

Aftermarket sway bars designed for attachment to the spring plate toe eccentric adjuster may be used. Bolt the drop link to the mounting tab on the Lower Plate that is aligned with the toe-eccentric hole.

Steel vs. Aluminum Trailing Arms

ASP can be used with aluminum ('74-'89 models) or steel ('69-'73) trailing arms. Steel arms are 8 mm thinner than aluminum trailing arms. If using steel trailing arms, supplement spacers 11 and 12 with an 8mm washer-stack.

Static Camber and Toe

Street cars should run factory-recommended camber and toe settings.

Competition cars should determine optimal static camber and toe settings using tire pyrometer readings and other traditional methods. As a starting point, reduce negative camber by 1 degree. Eg. If you run 3 degrees negative camber with a stock suspension, start with 2 degrees negative camber with the ASP.

Static camber and toe are adjusted using the upper and lower Double Adjusters (13a and 14a in the exploded view). Adjustment may be performed with vehicle weight loaded on the tires.

Left-and-right threading allows very-fine length changes by rotating the Double Adjusters - one direction to lengthen, the opposite direction to shorten. There is no need to unfasten the attached rod-ends.

Begin by loosening 2 jam nuts each securing upper and lower double adjusters.

Static Camber is set by rotating the upper and lower Double Adjusters equal amounts in opposite directions (lengthen one, shorten the other). Camber is made more negative by lengthening the upper Double Adjuster and shortening the lower Double Adjuster.

Toe is set by rotating the upper and lower Double Adjusters equal amounts in the same direction (lengthen or shorten in unison). Toe-In is increased by shortening both Double Adjusters.

Use camber and toe gauges to take measurements and continue making adjustments until desired settings are achieved.

Tighten 2 jam nuts each (2 each - 13b and 14b), locking upper and lower double adjusters.

Setting Ride Height:

Adjust height in two stages, Coarse and Fine. Coarse adjust is performed by indexing the torsion bars. Fine adjust is performed with the eccentric bolt joining the splined hub (20) and the blade assembly (13).

Determine your target coarse adjust droop-angle from the graphs. You need to know target ride height measured at the fender arch (assumes a 25 inch diameter tire), torsion bar diameter in millimeters (23-33mm), and the rear axle weight of the car. If weight is not known, use the factory published weight for your vehicle year, adjust based on estimated weight changes (fiberglass body parts, engine swaps, etc), then multiply the result by .60.

$$\text{Rear Axle Weight} = (\text{VIN Weight} + \text{Weight Change}) \times .60$$

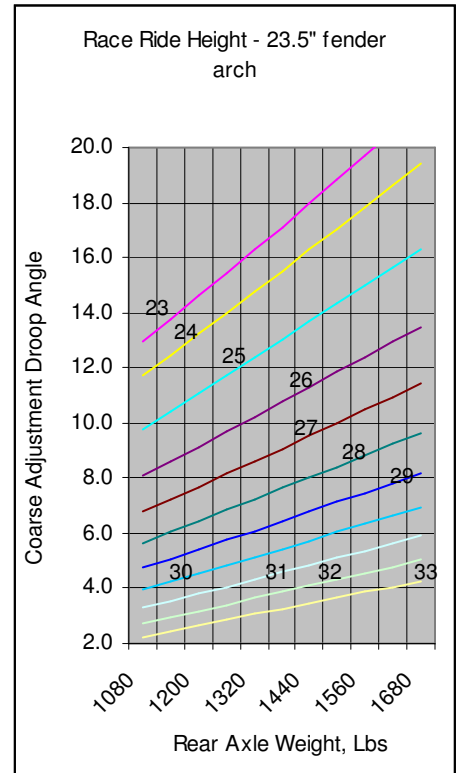
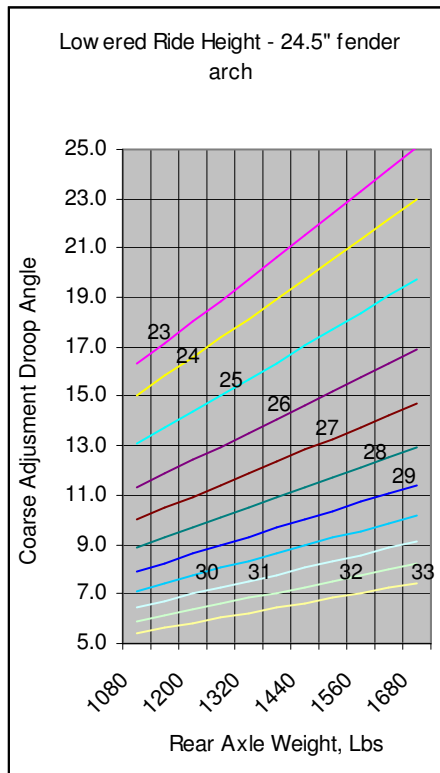
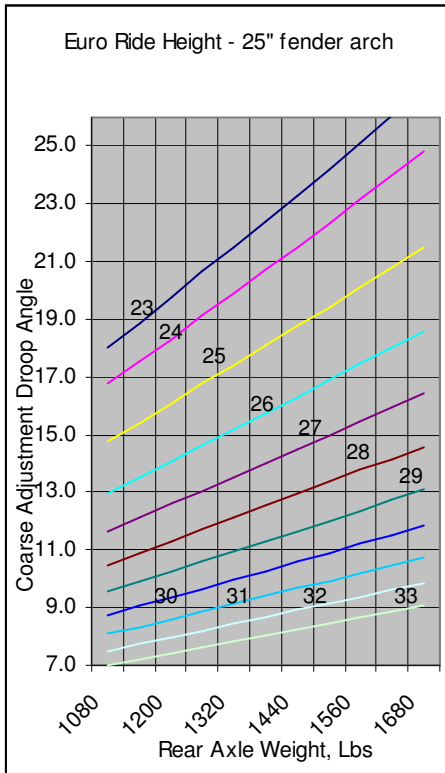

Coarse adjust – disconnect the blade assembly (13) from the trailing arm and leave hanging relaxed at full-droop. Center the fine-adjust eccentric bolt at mid-range. Level the doorsill.

Adjust the angle of the blade assembly using the splines on the torsion bar. The torsion bar has different counts on the inner and outer splines. This allows fine angular changes of less than 1 spline position by changing both inner and outer spline positions simultaneously.

Repeatedly alter both inner and outer spline positions to get within 1 degree of your target angle. A few minutes of trial-and-error attempts should get it.

Fine adjust – connect the blade assembly (13) to the trailing arm.

Rotate the eccentric bolt that joins the splined hub and the blade assembly until desired height is achieved. This requires a purpose made 36mm thin wrench. Fine adjust has a range of +/- 19mm. If you run out of range, repeat the coarse adjust with a different target droop angle.

Consult a shop manual for additional information about setting ride height.

